

Floating Fenders

PNEUMATIC FENDERS (HPF)

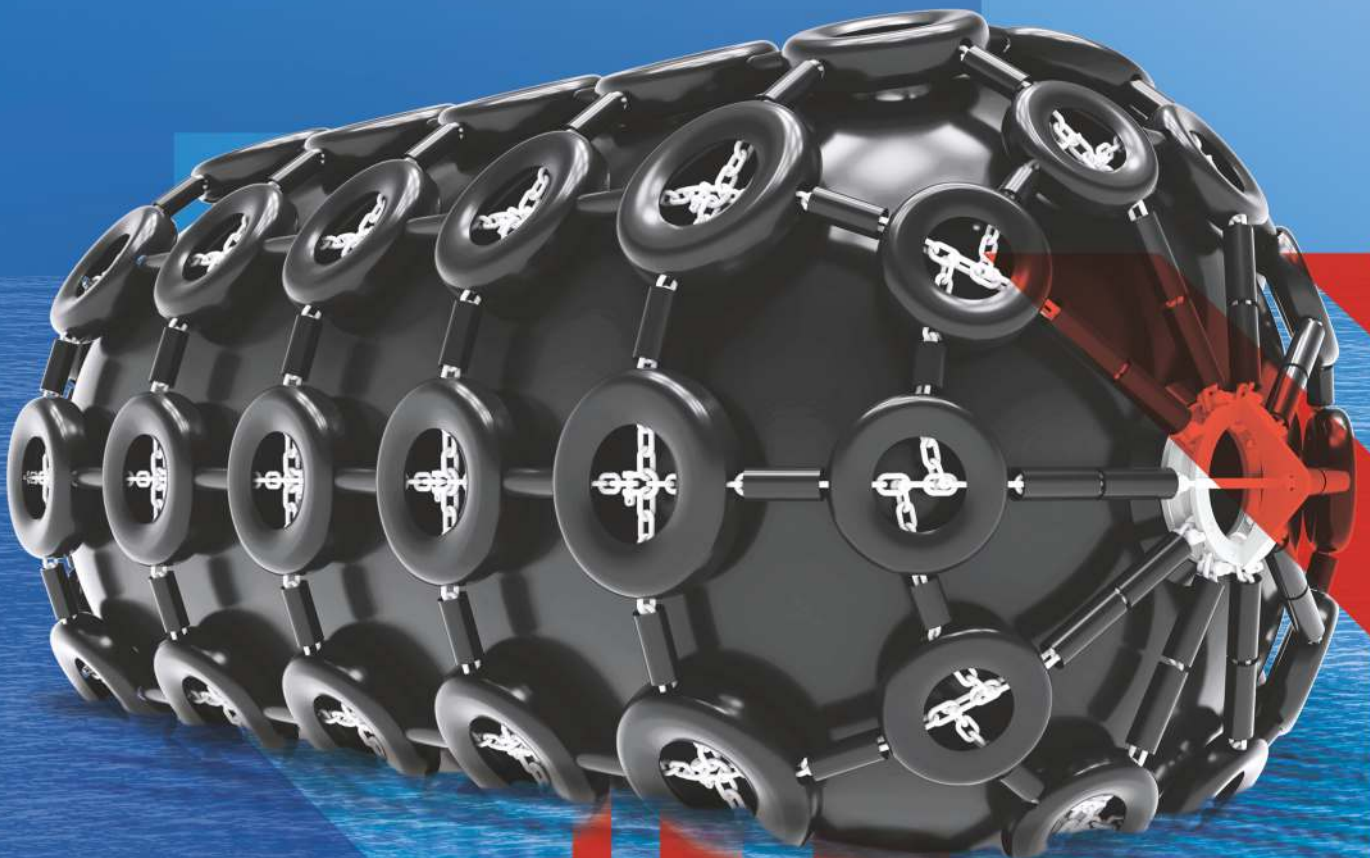

Where
Innovation
is Tradition



PNEUMATIC FENDERS (HPF)

Hi-Tech Pneumatic Fenders are high pressure air filled floating fender. HPF being the most versatile fenders are widely used for ship to ship operations. Hi-Tech pioneered the pneumatic fender in 1992 and have supplied thousands of fenders all around the world.

Hi-Tech Pneumatic Fenders are manufactured in accordance with ISO 17357-1:2014. Common internal pressures are 50kPa and 80kPa, others are available on request. Commonly HPF are sling type but bespoke Hi-Tech harnessings are used to protect the fender from wear and tear. Fender body and harnessing can be customized to suit a variety of applications such as grey or white body and harness.

FEATURES

- Widely used for ship to ship, remote berthing, inclined berthing and naval operations
- Compared to other fenders pneumatic fenders have very low reaction to ship and jetty structure
- Adaptable to high tide variations
- Low mooring forces exerted under tough weather
- In most situations it is the most cost effective solution
- Quick and simple deployment

APPLICATIONS

- Oil and Gas Tankers <Ship-to-Ship>
- Fast Ferries and Aluminium Vessels
- Temporary and Permanent Installations
- Rapid Response and Emergency
- Used in naval establishments

PNEUMATIC FENDERS (HPF)

CONSTRUCTION

Pneumatic fenders are made of mainly 3 types of layers i.e. outer rubber, chord fabric layer and inner rubber layer.

OUTER RUBBER

Outer layer is made of high abrasion resistant and high elongation rubber. It is designed to protect against wear and punchers that may happen during extreme conditions. The rubber is specially formulated to withstand harshest of berthing conditions. The rubber is UV resistant which allows the rubber to not degrade over the years with exposure to seawater and sunlight. Generally the outer layer is made of black rubber. Grey outer rubber layer is used for non marking application such as cruise and naval terminals.

SYNTHETIC CHORD LAYER

Synthetic chord layer is a special chord developed to have high tensile strength. It is similar to the chord layer found in car tyres. Synthetic chords are molded between rubber sheets to form the chord layer. This layer gives the fender its strength during compression. This layer is layed in the direction of compression and resists over compression as well as provides strength to fender body. The number of layers depend upon the working internal pressure and the operating condition that the fender may be exposed to.

INNER RUBBER

Inner layer of a pneumatic fender is designed to be water and air leak proof. This layer is responsible for sealing the fender from internal or external leakages during high pressure situations like peak compression. The inner layer is susceptible to both tension and compression thus the rubber properties are specially formulated at the highest quality standard to cater to these harsh conditions. This layer also is responsible for long service life of the fender thus no cracks or degradation must occur on the inner later.

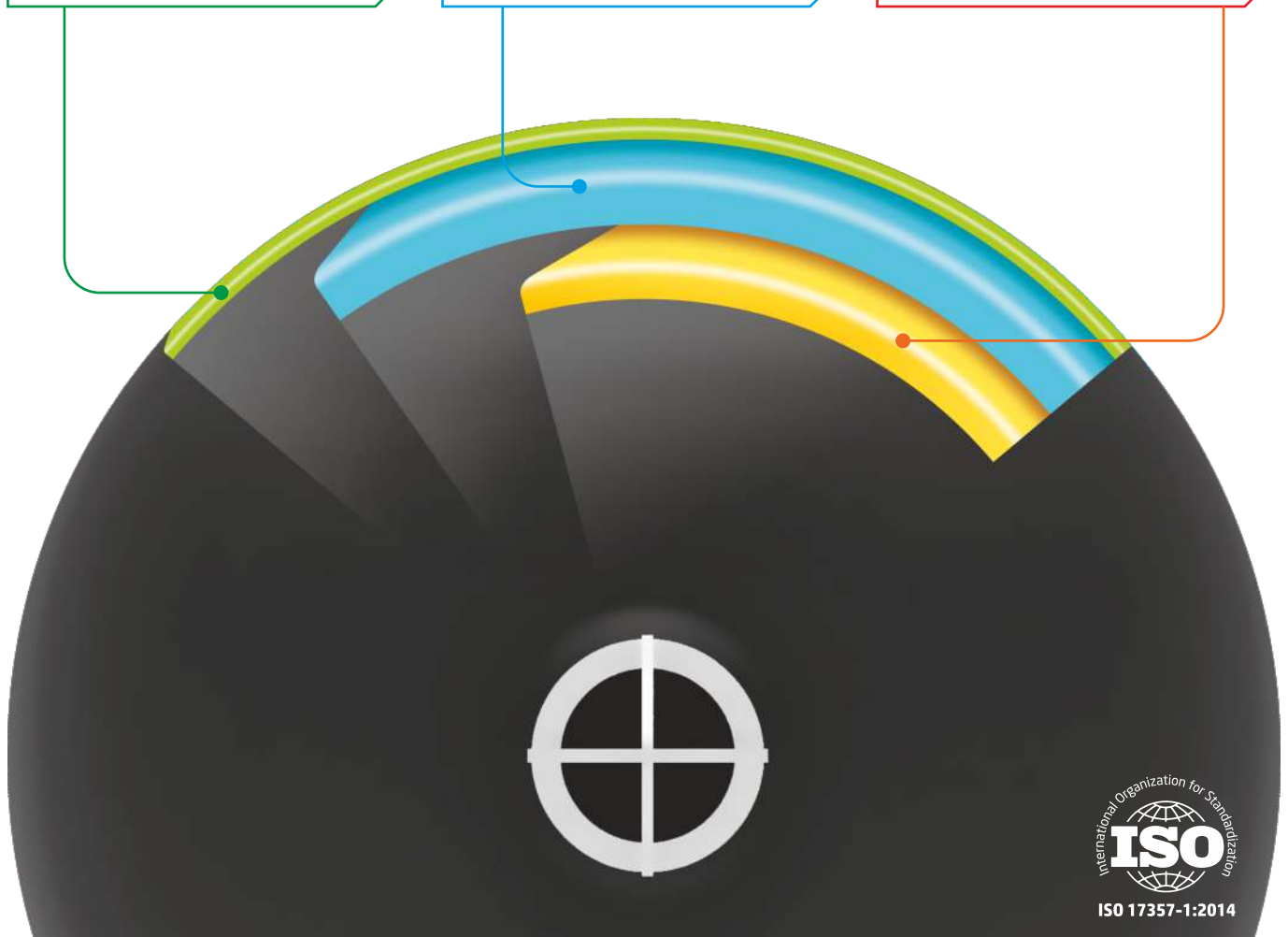

PNEUMATIC FENDERS (HPF)

CONSTRUCTION: VALVE BODY AND BEAD RING ARRANGEMENT

Diameter of the bead ring or other steel material around the flange opening shall be less than 0.20 D (D: fender diameter) to make metal parts safe from permanent deformation when it gets over compression near to 80%.

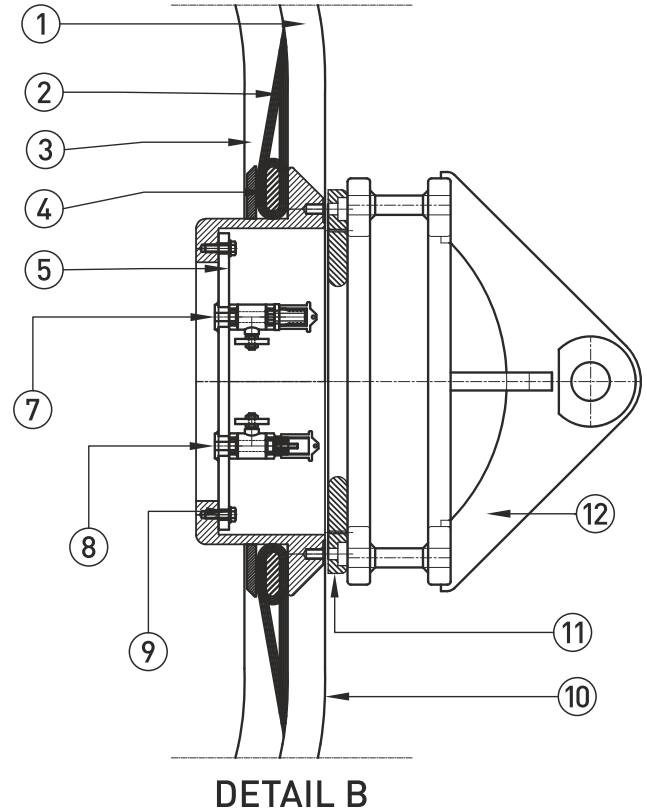
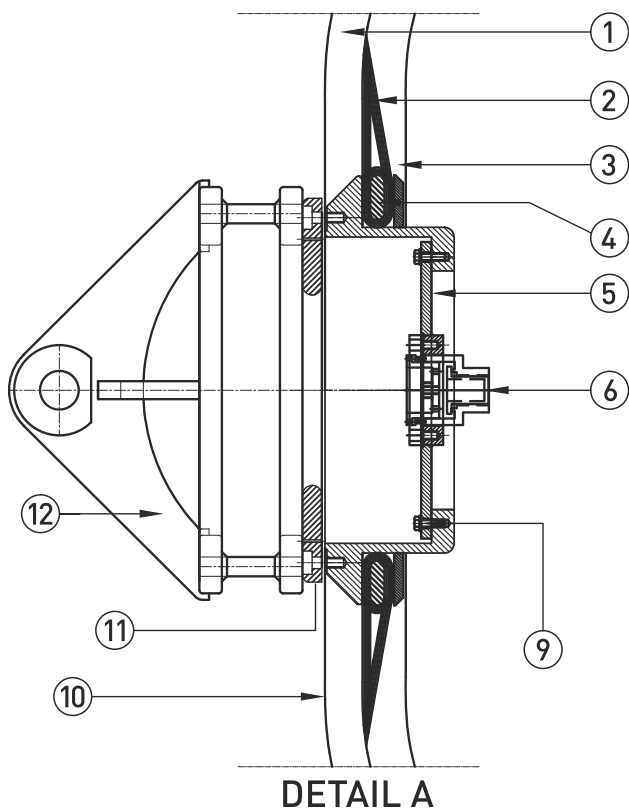

PART NO.	PART LIST
1	Outer Rubber Layer
2	Tyre-Cord Layer
3	Inner Rubber Layer
4	Bead Ring
5	Flange Opening
6	Safety Valve
7	Air Charging Valve Assembly
8	Air Check Valve
9	Flange Fixing Fasteners
10	Fender Body
11	Top Plate
12	End Ring Hook

PNEUMATIC FENDERS (HPF)

OUTER AND INNER RUBBER MATERIAL PROPERTIES REQUIREMENTS

The material tests of the outer and inner rubber shall be conducted in accordance with the specification given in the table below.

TEST ITEM	TEST METHOD	REQUIRED VALUE	
		OUTER RUBBER	INNER RUBBER
Before Ageing		Original	Original
Tensile Strength	BS ISO 37	18 MPa or more	10 MPa or more
Elongation	BS ISO 37	400% or more	400% or more
Hardness	ISO 7619	60 +/- 10 (durometer hardness test type A)	50 +/- 10 (durometer hardness test type A)
After Ageing	ISO 188	Air oven ageing. 70°C +/- 1°C. 96 h	Air oven ageing. 70°C +/- 1°C. 96 h
Tensile Strength	BS ISO 37	Not less than 80% of the original property	Not less than 80% of the original property
Elongation	BS ISO 37	Not less than 80% of the original property	Not less than 80% of the original property
Hardness	ISO 7619	Not to exceed the original property by more than 8	Not to exceed the original property by more than 8
Tear	BS ISO 34-1	400 N/cm or more	No requirement
Compression Set	ISO 815	30% (70°C +/- 1°C for 22h) or less	No requirement
Static Ozone Resistance	ISO 1431-1	No cracks after elongation by 20% and exposure to 50 ppm ₁ at 40°C for 96 h.	No requirement

NOTE: If the color of the outer rubber is not black, the material requirements will differ from those in this table. 1 ppm: parts of ozone per hundred million of air by volume.

Properties of the inner and outer rubber as adapted from ISO 17357-1:2014 Ships and Marine Technology High-pressure Floating Pneumatic Rubber Fenders.

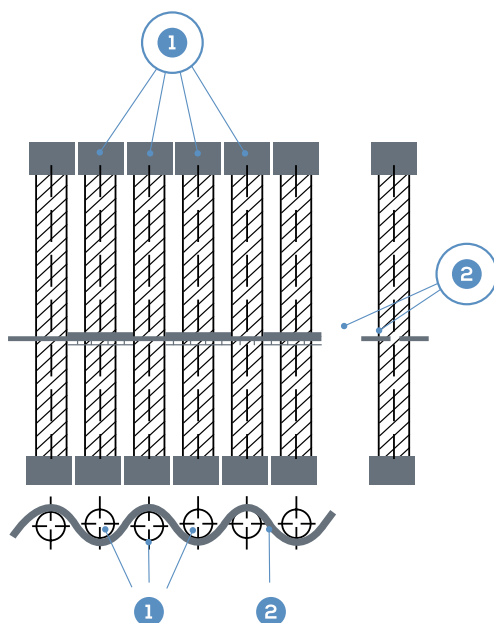

Construction of tire-cord layers as adapted from ISO 17357-1:2014.

- 1 Warp synthetic cords are lined in vertical direction.
- 2 Weft synthetic cords are lined in horizontal direction.

PNEUMATIC FENDERS (HPF)

STANDARD SIZES

Regardless of type or pressure, fenders are measured by diameter and length, generally expressed in millimeters (mm). Type I (chain-tire net) fenders are not available below 800 x 1200. All fenders with diameter 2500 mm and above are fitted with a pressure relief valve in accordance with ISO 17357- 1:2014.

SIZE (OD X L) (mm)	BODY MASS (kg)	CTN MASS (kg)	TOTAL MASS (kg)	CHAIN (mm)
500 × 1000	35	–	35	13
1000 × 1500	140	170	310	16
1000 × 2000 ^	170	200	370	16
1200 × 2000	200	220	420	18
1350 × 2500	270	260	530	20
1500 × 3000*	350	440	790	22
2000 × 3500*	650	920	1570	28
2500 × 4000	1100	1510	2610	32
2500 × 5500*	1350	1620	2970	36
3300 × 4500	1800	2360	4160	38
3300 × 6500 ^	2250	3120	5370	44
3300 × 10600	2800	4050	6850	48
4500 × 9000*	4950	6200	11150	50

Other sizes available upon request* standard tolerances may apply for these values, for more accurate data please contact Hi-Tech office.

NON-STANDARD SIZES

SIZE (OD X L) (mm)	SIZE (OD X L) (mm)
300 × 500	1700 × 3000
300 × 600	1700 × 7200
500 × 800	2000 × 3000
800 × 1200	2000 × 6000
800 × 1500	3000 × 5000
1200 × 1800	4500 × 7000
1500 × 2500	4500 × 12000

Some applications may require sizes and specification outside of those specified in the standards. Hi-Tech Elastomers operation can customize fenders to meet your specifications.

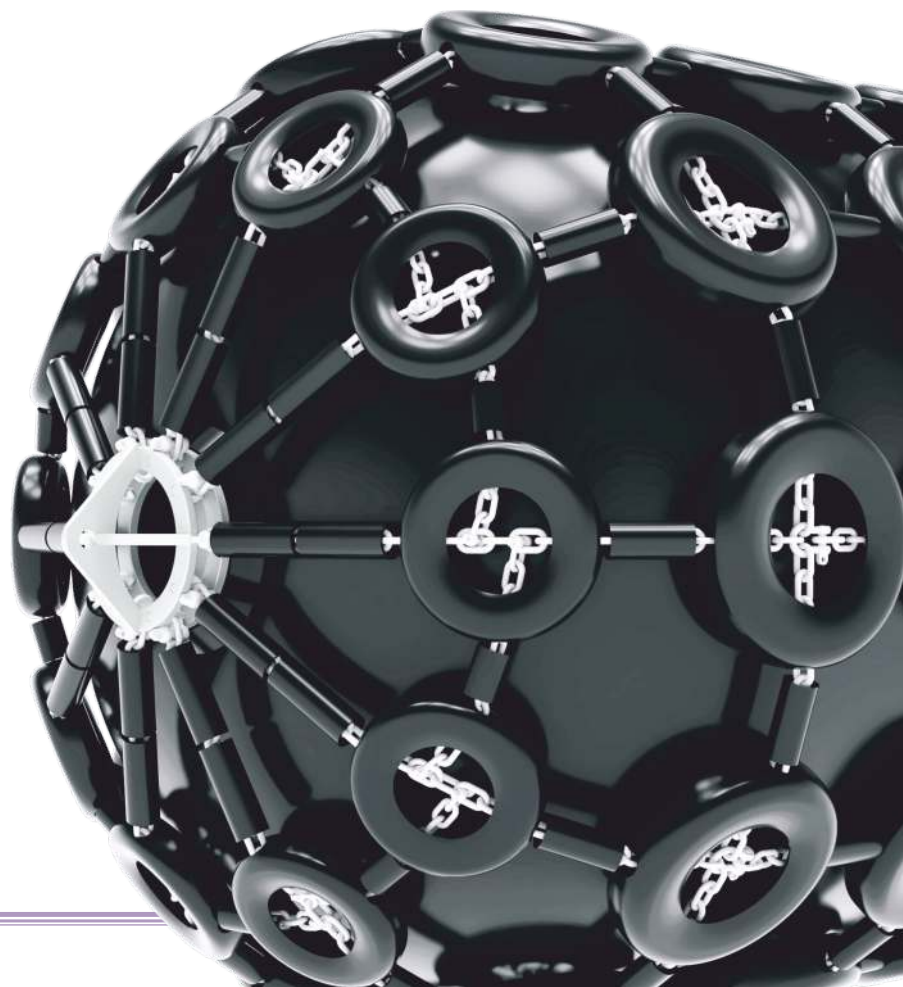

PNEUMATIC FENDERS (HPF)

PERFORMANCE DATA

INITIAL INTERNAL PRESSURE	50kPa			80kPa		
NOMINAL SIZE DIAMETER x LENGTH (mm)	GUARANTEED ENERGY ABSORPTION (GEA)	REACTION FORCE AT GEA DEFLECTION (R)	HULL PRESSURE (INTERNAL PRESSURE) AT GEA DEFLECTION (P)	GUARANTEED ENERGY ABSORPTION (GEA)	REACTION FORCE AT GEA DEFLECTION (R)	HULL PRESSURE (INTERNAL PRESSURE) AT GEA DEFLECTION (P)
	MINIMUM VALUE AT DEFLECTION 60 ± 5 kJ	TOLERANCE ±10 kN	REFERENCE VALUE kPa	MINIMUM VALUE AT DEFLECTION 60 ± 5 kJ	TOLERANCE ±10 kN	REFERENCE VALUE kPa
500 x 1000	6	64	132	8	85	174
1000 x 1500	32	182	122	45	239	160
1000 x 2000	45	257	132	63	338	174
1200 x 2000	63	297	126	88	390	166
1350 x 2500	102	427	130	142	561	170
1500 x 3000	153	579	132	214	761	174
2000 x 3500	308	875	128	430	1150	168
2500 x 4000	663	1381	137	925	1815	180
2500 x 5500	943	2019	148	1317	2653	195
3300 x 4500	1175	1884	130	1640	2476	171
3300 x 6500	1814	3015	146	2532	3961	191
3300 x 10600	3067	5257	158	4281	6907	208
4500 x 9000	4752	5747	146	6633	7551	192

Standard tolerances may apply for these values, for more accurate data please contact Hi-Tech office.

PERFORMANCE CURVE

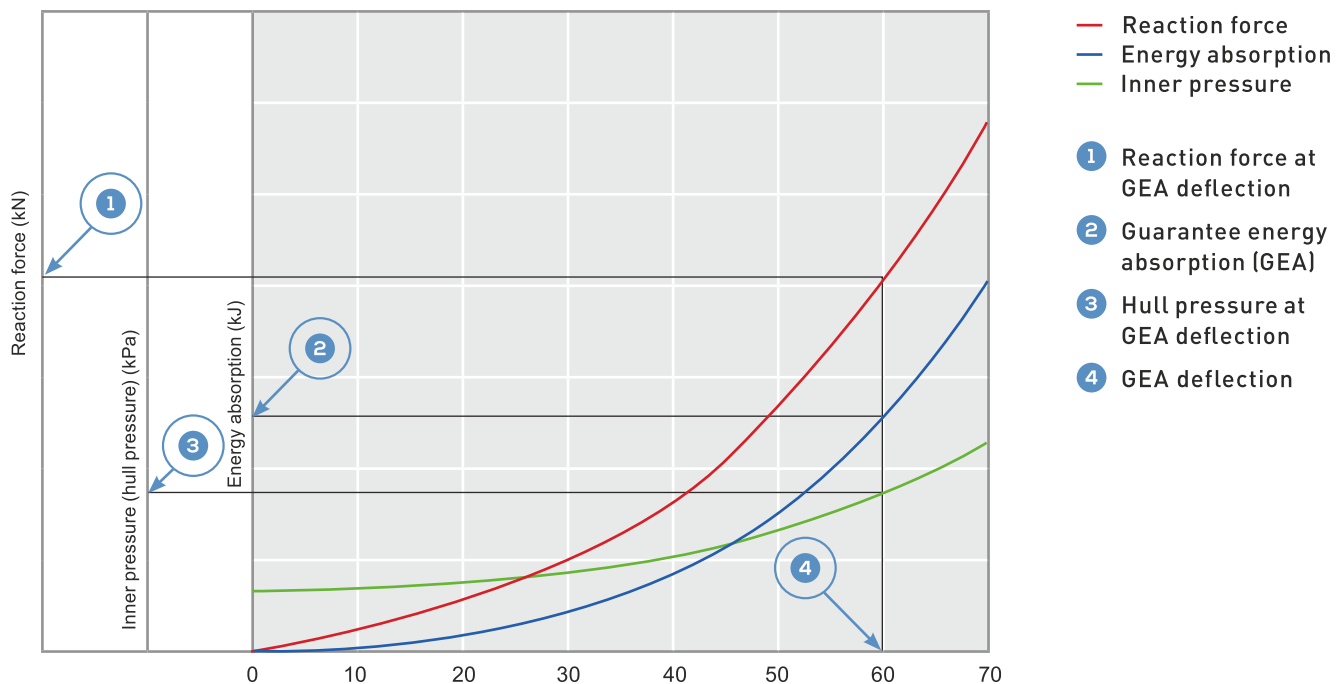

PNEUMATIC FENDERS (HPF)

TEST AND INSPECTION REQUIREMENTS

Acceptance testing and inspection for purchased fenders shall be based on the tests and inspections indicated in the following table:

Test and inspection requirements for commercial fenders as per ISO 17357-1:2014

TEST	STANDARD	DESCRIPTION	REMARKS
Confirmation from material certificate that tire cord is used	ISO 17357- 1:2014/PIANC Guidelines for design of fender systems: 2002	Synthetic-tire-cord layers have been proven to provide strong efficient reinforcement layers in fenders. Each single layer is coated with rubber compound on both sides as well as in between synthetic-tire-cord threads, hence isolating all cords from each other.	If alternative reinforcement methods to tire cord are used, test certificates proving that strength and durability are designed and proven to be equal or superior to the tire cord after exhaustive trials, shall be evaluated and certified by a major classification society as well as a material certificate used for the ordered fenders.
Material testing		Physical properties of inner and outer rubber.	Tensile / elongation / hardness before ageing to be tested once for each order. The rest of the tests should be conducted once a year.
Dimensional inspection		Length : +10%, -5% Diameter: +10%, -5%	Dimensional inspection to be carried out at initial internal pressure (working pressure).
Air leakage		The air leakage test shall be conducted at initial informal pressure for more than 30 minutes.	All fenders to be tested for each and every order.
Hydrostatic test		Test shall be preformed for 10 minutes at hydrostatic pressure shown in 'Pressure Rating' table. Maximum circumferential and longitudinal temporary elongation: 10%	The frequency of test shall be one in 20 fenders for each size and pressure.
Witness and confirmation of marking.		Each fender shall have markings to indicate the following: <ul style="list-style-type: none"> • International standard applicable year • Size • Initial internal pressure • Date of manufacture • Name of manufacturer • Individual serial number • Type of reinforcement layer 	The identification system shall be designed to last throughout the fender's life.

Standard tolerances may apply for these values, for more accurate data please contact Hi-Tech office.

PNEUMATIC FENDERS (HPF)

PRESSURE RATINGS

Hi-Tech manufactures fenders with two initial pressures: 50 kPa (Pneumatic 50) and 80 kPa (Pneumatic 80). Design values are given below.

For 50 kPa internal pressure

PNEUMATIC 50 SIZE (OD x L) (mm)	INTERNAL PRESSURE (kPa)		MIN. ENDURABLE PRESSURE (kPa)		SAFETY VALVE PRESSURE SETTING (kPa)	TEST PRESSURE AT 0% DEFLECTION (kPa)
	AT 0% DEFLECTION	AT 60% DEFLECTION	AT 0% DEFLECTION	AT 60% DEFLECTION		
500 x 1000	50	132	300	462	–	200
1000 x 1500	50	122	300	427	–	200
1000 x 2000	50	132	300	462	–	200
1200 x 2000	50	126	300	441	–	200
1350 x 2500	50	130	300	455	–	200
1500 x 3000	50	132	300	462	–	200
2000 x 3500	50	128	300	448	–	200
2500 x 4000	50	137	350	480	175	250
2500 x 5500	50	148	350	518	175	250
3300 x 4500	50	130	350	455	175	250
3300 x 6500	50	146	350	511	175	250
3300 x 10600	50	158	350	553	175	250
4500 x 9000	50	146	350	511	175	250

Standard tolerances may apply for these values, for more accurate data please contact Hi-Tech office.

For 80 kPa internal pressure

PNEUMATIC 80 SIZE (OD x L) (mm)	INTERNAL PRESSURE (kPa)		MIN. ENDURABLE PRESSURE (kPa)		SAFETY VALVE PRESSURE SETTING (kPa)	TEST PRESSURE AT 0% DEFLECTION (kPa)
	AT 0% DEFLECTION	AT 60% DEFLECTION	AT 0% DEFLECTION	AT 60% DEFLECTION		
500 x 1000	80	174	480	609	–	250
1000 x 1500	80	160	480	560	–	250
1000 x 2000	80	174	480	609	–	250
1200 x 2000	80	166	480	581	–	250
1350 x 2500	80	170	480	595	–	250
1500 x 3000	80	174	480	609	–	250
2000 x 3500	80	168	480	588	–	250
2500 x 4000	80	180	560	630	230	300
2500 x 5500	80	195	560	683	230	300
3300 x 4500	80	171	560	599	230	300
3300 x 6500	80	191	560	669	230	300
3300 x 10600	80	208	560	728	230	300
4500 x 9000	80	192	560	672	230	300

Standard tolerances may apply for these values, for more accurate data please contact Hi-Tech office.

PNEUMATIC FENDERS (HPF)

TYPES OF FENDERS

There are two basic types of Pneumatic Fenders that comply with the international standard ISO 17357-1:2014: Type I (net type) and Type II (sling type). The most appropriate type for a given application is dependent on how the fender is used and the facility's requirements.

TYPE I: CHAIN-TIRE-NET (CTN) TYPE

STANDARD CHAIN NET (HPF-SCN)

FEATURES & ADVANTAGES

- Low carbon footprint (made from used tyres)
- Simple and fast to install
- Provide good life against abrasion
- Prevent the Ship's hull from damage
- Rugged body protects the fender against cutting/puncturing from sharp objects

APPLICATIONS:

- Used in Ship-to-Ship Transfers
- Used as a solution for temporary and/or emergency fendering systems
- Used for tankers/gas carriers/bulk cargo ships, fast ferries & other aluminium hull vessels

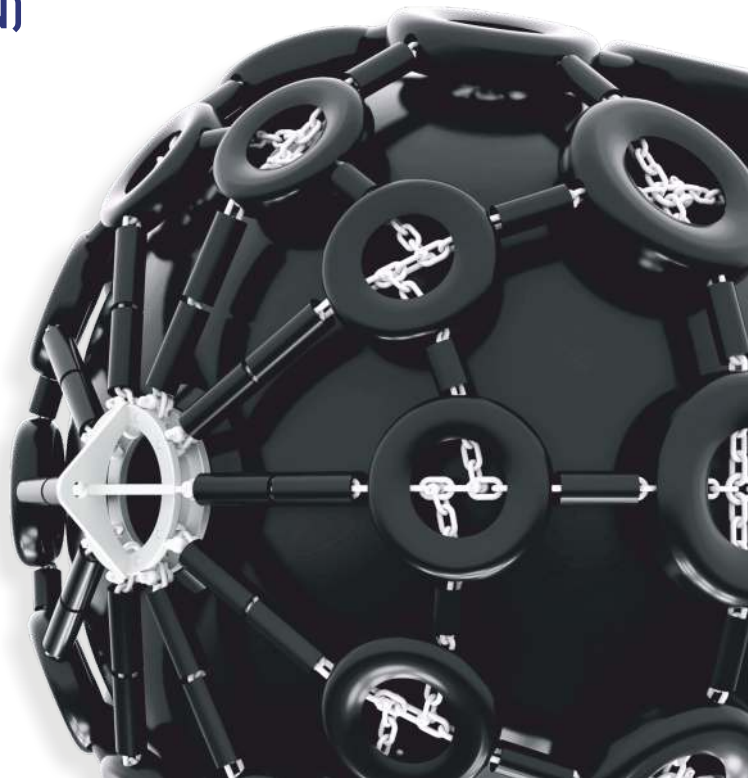

AIRCRAFT TYRE CHAIN NET (HPF-ACN)

FEATURES & ADVANTAGES

- Manufactured from Aircraft tyres/ Specially moulded tyres
- Longer service life in comparison to standard chain net
- Low maintenance cost

APPLICATIONS:

- Used in Ship-to-Ship Transfers
- Used as a solution for temporary and/or emergency fendering system installations
- Used for tankers, gas carriers, bulk cargo ships, fast ferries & other aluminium hull vessels

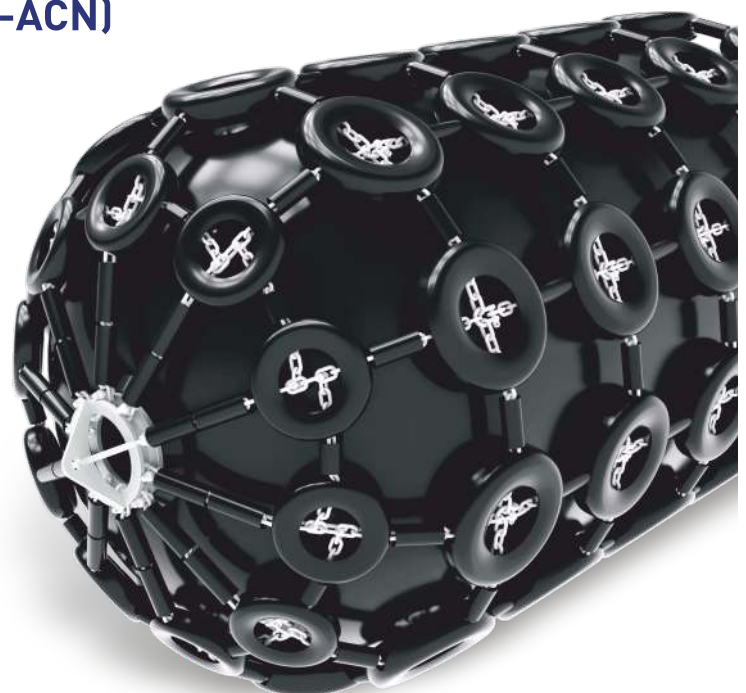

PNEUMATIC FENDERS (HPF)

TYPES OF FENDERS

GREY BODY GREY HARNESSING (HPF-GBGH)

FEATURES & ADVANTAGES

- Grey body and grey harnessing fenders are used where ships require absolute non marking fenders
- Lower cost of painting the hull of the ship

APPLICATIONS:

- Especially useful for naval ships and cruise terminals

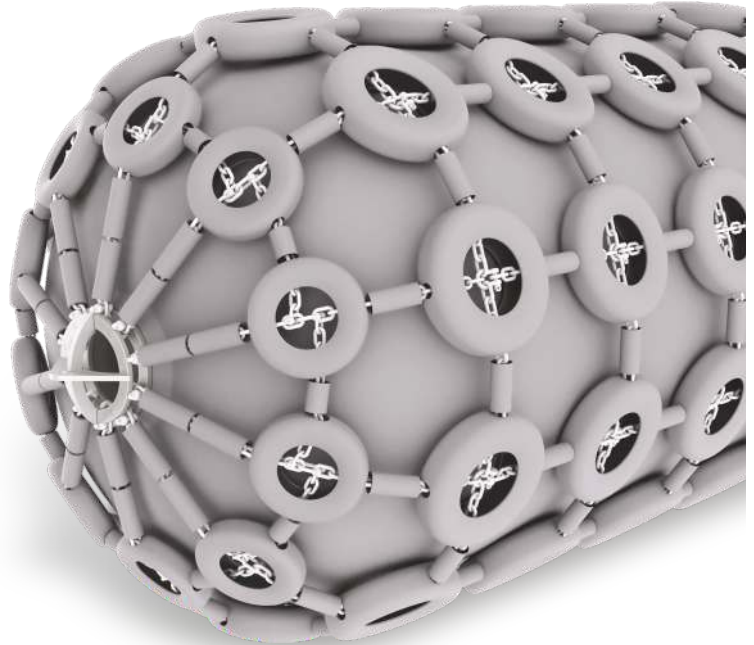

GREY HARNESSING(HPF-GH)

FEATURES & ADVANTAGES

- Special chain net harnessing with non-marking grey/white tyres & grey/white sleeves
- Grey harnessing overcomes the problem of black marks during the berthing

APPLICATIONS:

- Especially useful for naval ships
- Use in Ship-to-Ship Transfers
- Used as a solution for temporary and/or emergency fendering system

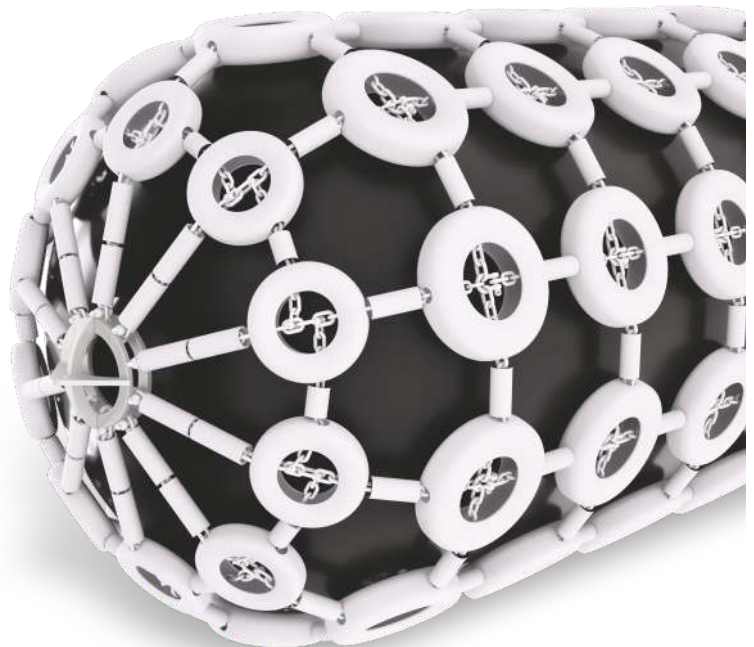

ON SPECIAL DEMAND, THE FOLLOWING UPGRADES ARE AVAILABLE:

- Rubber moulded chain
- Grey moulded tyre
- Stainless steel chain and harnessing
- Air pressure and temperature monitor

PNEUMATIC FENDERS (HPF)

TYPES OF FENDERS

TYPE II: SLING OR HOOK TYPE

SLING-TYPE (HPF-SB)

FEATURES & ADVANTAGES

- Sling type fenders don't have a harnessing thus they have a thick outer layer of rubber to have better abrasion resistance and long life
- There is no steel chain in contact between ship and jetty thus it prevents any damages that might happen during berthing
- Faster installation and very low maintenance
- Suitable for small and large tidal ranges
- Maintains large clearances between hull and structure

APPLICATIONS:

- HPF-SB is most widely used for naval applications
- Passenger vessels
- Vessels that have sensitive hull structures



SLING-TYPE GREY BODY (HPF-SG)

FEATURES & ADVANTAGES

- Grey sling type fenders have all the features of the regular sling type fenders
- Grey outer layer of rubber is used in non-marking applications
- HPF-SG is available in white/grey colour
- Faster installation and very low maintenance

APPLICATIONS:

- HPF-SG is most widely used for naval applications (non-marking applications)
- Passenger vessels and where abrasion due to the harnessing is not acceptable

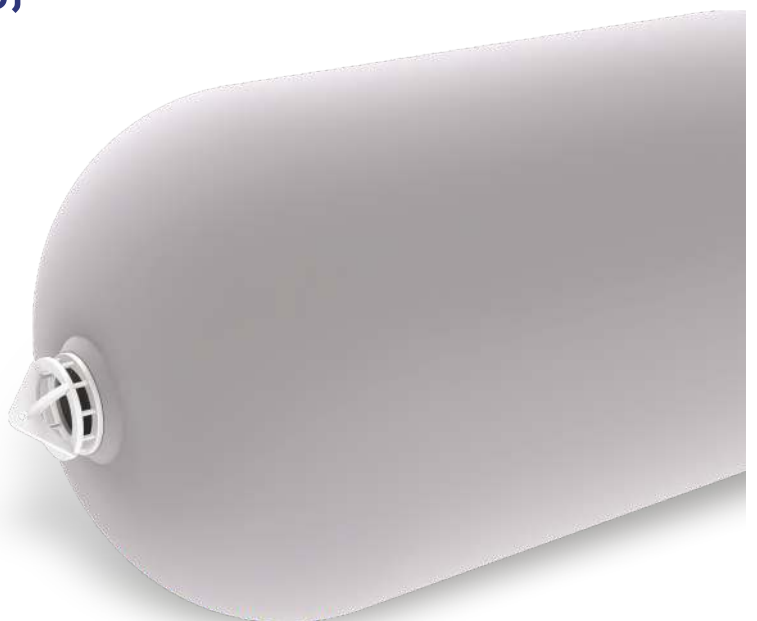

PNEUMATIC FENDERS (HPF)

END FITTINGS

Pneumatic fenders are often suspended using chains, shackles. Recommended dimensions of the standard fittings are given in the table below

FENDER FIXING ACCESSORIES (50 kPa INITIAL PRESSURE)

TYPE 2 FENDER (SLING)		FIRST SHACKLE DIAMETER mm (inch)	SWIVEL DIAMETER mm (inch)	OTHER SHACKLE DIAMETER mm (inch)	GUY ROPE DIAMETER mm (inch)	GUY CHAIN DIAMETER mm (inch)	ANCHOR DIAMETER mm (inch)
SIZE (OD x L) (mm)	INITIAL PRESSURE (kPa)						
1000 x 1500	50	19 (3/4)	19 (3/4)	19 (3/4)	16 (5/8)	16 (5/8)	25 (1)
1000 x 2000	50	19 (3/4)	19 (3/4)	19 (3/4)	16 (5/8)	16 (5/8)	25 (1)
1200 x 1800	50	19 (3/4)	19 (3/4)	19 (3/4)	16 (5/8)	16 (5/8)	25 (1)
1200 x 2000	50	19 (3/4)	19 (3/4)	19 (3/4)	16 (5/8)	16 (5/8)	25 (1)
1350 x 2500	50	22 (7/8)	22 (7/8)	22 (7/8)	18 (11/16)	16 (5/8)	25 (1)
1500 x 2500	50	22 (7/8)	22 (7/8)	22 (7/8)	20 (13/16)	19 (3/4)	32 (1-1/4)
1500 x 3000	50	22 (7/8)	22 (7/8)	22 (7/8)	20 (13/16)	19 (3/4)	32 (1-1/4)
1700 x 3000	50	25 (1)	25 (1)	25 (1)	24 (15/16)	22 (7/8)	32 (1-1/4)
2000 x 3000	50	25 (1)	25 (1)	25 (1)	24 (15/16)	22 (7/8)	32 (1-1/4)
2000 x 3500	50	25 (1)	25 (1)	25 (1)	24 (15/16)	22 (7/8)	32 (1-1/4)
2000 x 6000	50	32 (1-1/4)	32 (1-1/4)	32 (1-1/4)	30 (1-3/16)	26 (1)	36 (1-7/16)
2500 x 4000	50	32 (1-1/4)	32 (1-1/4)	32 (1-1/4)	30 (1-3/16)	26 (1)	42 (1-5/8)
2500 x 5500	50	32 (1-1/4)	32 (1-1/4)	32 (1-1/4)	34 (1-3/8)	32 (1-1/4)	44 (1-3/4)
3000 x 5000	50	38 (1-1/2)	38 (1-1/2)	38 (1-1/2)	34 (1-3/8)	30 (1-3/16)	44 (1-3/4)
3300 x 4500	50	44 (1-3/4)	38 (1-1/2)	44 (1-3/4)	34 (1-3/8)	30 (1-3/16)	44 (1-3/4)
3300 x 6500	50	44 (1-3/4)	38 (1-1/2)	44 (1-3/4)	42 (1-5/8)	38 (1-1/2)	55 (2-3/16)
4500 x 9000	50	44 (1-3/4) (2 Qty)	44 (1-3/4)	44 (1-3/4)	42 (1-5/8)	38 (1-1/2)	55 (2-3/16)

FENDER FIXING ACCESSORIES (80 kPa INITIAL PRESSURE)

TYPE 2 FENDER (SLING)		FIRST SHACKLE DIAMETER mm (inch)	SWIVEL DIAMETER mm (inch)	OTHER SHACKLE DIAMETER mm (inch)	GUY ROPE DIAMETER mm (inch)	GUY CHAIN DIAMETER mm (inch)	ANCHOR DIAMETER mm (inch)
SIZE (OD x L) (mm)	INITIAL PRESSURE (kPa)						
1000 x 1500	80	19 (3/4)	19 (3/4)	19 (3/4)	16 (5/8)	16 (5/8)	25 (1)
1000 x 2000	80	19 (3/4)	19 (3/4)	19 (3/4)	18 (11/16)	16 (5/8)	25 (1)
1200 x 1800	80	19 (3/4)	19 (3/4)	19 (3/4)	18 (11/16)	16 (5/8)	25 (1)
1200 x 2000	80	19 (3/4)	19 (3/4)	19 (3/4)	18 (11/16)	16 (5/8)	25 (1)
1350 x 2500	80	22 (7/8)	22 (7/8)	22 (7/8)	20 (13/16)	19 (3/4)	25 (1)
1500 x 2500	80	22 (7/8)	22 (7/8)	22 (7/8)	20 (13/16)	19 (3/4)	32 (1-1/4)
1500 x 3000	80	22 (7/8)	22 (7/8)	22 (7/8)	20 (13/16)	19 (3/4)	32 (1-1/4)
1700 x 3000	80	25 (1)	25 (1)	25 (1)	24 (15/16)	22 (7/8)	32 (1-1/4)
2000 x 3000	80	25 (1)	25 (1)	25 (1)	24 (15/16)	22 (7/8)	36 (1-7/16)
2000 x 3500	80	25 (1)	25 (1)	25 (1)	24 (15/16)	22 (7/8)	36 (1-7/16)
2000 x 6000	80	32 (1-1/4)	32 (1-1/4)	32 (1-1/4)	30 (1-3/16)	26 (1)	42 (1-5/8)
2500 x 4000	80	32 (1-1/4)	32 (1-1/4)	32 (1-1/4)	30 (1-3/16)	26 (1)	42 (1-5/8)
2500 x 5500	80	32 (1-1/4)	32 (1-1/4)	32 (1-1/4)	34 (1-3/8)	32 (1-1/4)	44 (1-3/4)
3000 x 5000	80	38 (1-1/2)	38 (1-1/2)	38 (1-1/2)	34 (1-3/8)	30 (1-3/16)	44 (1-3/4)
3300 x 4500	80	44 (1-3/4)	38 (1-1/2)	44 (1-3/4)	38 (1-1/2)	34 (1-3/8)	50 (2)
3300 x 6500	80	44 (1-3/4)	38 (1-1/2)	44 (1-3/4)	46 (1-13/16)	42 (1-5/8)	60 (2-3/8)
4500 x 9000	80	44 (1-3/4) (2 Qty)	44 (1-3/4)	44 (1-3/4)	42 (1-5/8)	38 (1-1/2)	60 (2-3/8)

Recommended sizes of shackles and chains for all sizes of Type II fenders.

PNEUMATIC FENDERS (HPF)

INSTALLATION DIMENSIONS

Pneumatic fenders must be installed onto a solid structure or reaction panel to ensure that they are properly supported during impacts.

CHAIN TIRE NET (CTN) FENDERS							
FENDER SIZE		A	B	C	D	E	W
DIAMETER	LENGTH						
1000	1500	825	940	1340	345	515	1950
1200	2000	1100	1130	1610	305	510	2600
1500	2500	1485	1410	2010	270	525	3250
2000	3500	1965	1880	2680	375	715	4550
2500	4000	2495	2355	3355	430	855	5200
3300	6500	3365	3110	4430	500	1065	8450
4500	9000	4605	4240	6040	665	1435	11700

SLING FENDERS							
FENDER SIZE		A	B	C	D	E	W
DIAMETER	LENGTH						
1000	1500	1020	940	1340	150	320	1950
1200	2000	1265	1130	1610	140	345	2600
1500	2500	1575	1410	2010	180	435	3250
2000	3500	2125	1880	2680	215	555	4550
2500	4000	2675	2355	3355	250	675	5200
3300	6500	3605	3110	4430	260	825	8450
4500	9000	4935	4240	6040	335	1105	11700

Jetty/quay or dolphin

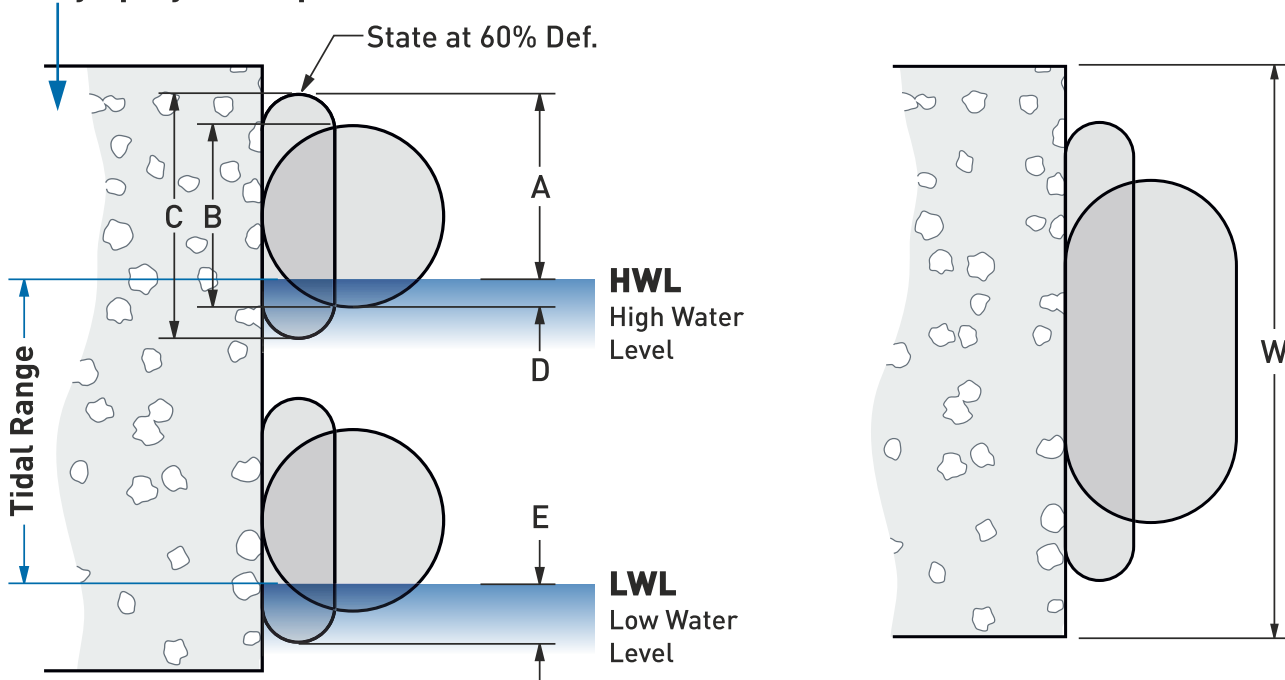

PNEUMATIC FENDERS (HPF)

SHIP-TO-SHIP APPLICATIONS

The ideal fenders for STS transfer operations are pneumatic. Quick and easy to install, these fenders ensure that safe distances are maintained between vessels, absorbing impacts.

While ship-to-ship operations are very common in maritime trade, they pose certain risks. Let's have a look at why STS operations are so much in vogue and how to minimise any of these risks through the use of appropriate fenders.

It is firstly important to understand what a ship to ship (STS) operation is. It involves a merchandise exchange operation between two ships that are side by side that can be stopped or even moving. It occurs in the following situations:

- Between tankers (oil and gas).
- In large vessels whose draft prevents them from docking in a port or dock to unload there.
- STS operations are recommended whenever a port or terminal becomes congested, therefore preventing any bottleneck.
- Bunkering operations for the transfer of fuel.

This operation is therefore becoming more and more common since new ships are getting bigger and the terminals are often not prepared to receive them. It is also very economical and fast, since it eliminates docking costs as well as the time spent at the port.

One disadvantage is the environmental and fire risk due to the fact that the boats are not moored, increasing the possibilities of spillage during the operation. There is also a danger of collisions between ships that could cause damage to the hulls.



PRODUCT INSTALLATION PICTURES



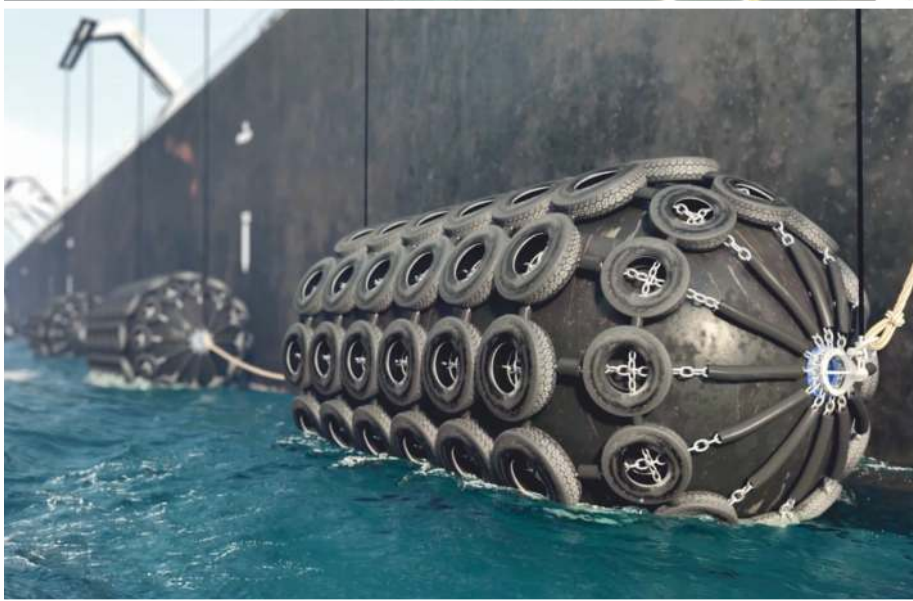



HI-TECH ELASTOMERS LTD.

WHERE INNOVATION IS A TRADITION

OFFICE

227, Hitech Elastomers, Santej-Vadsar Road,
Gandhinagar, Gujarat, INDIA - 384004.

Phone : +91-9824 654 671

Email : vpsales@hitechelastomers.com
sales1@hitechelastomers.com
sales@hitechelastomers.com

MANUFACTURING PLANT I:

798, Sola-Kalol Highway, Rakanpur,
Dist.: Gandhinagar, Gujarat, INDIA - 384002.

MANUFACTURING PLANT II:

227, Santej-Vadsar Road, Santej,
Dist. Gandhinagar, Gujarat, INDIA - 384004.

www.hitechelastomers.com